

# CARVIN

## Quad X-Amp TUBE GUITAR PREAMP

### User's Guide

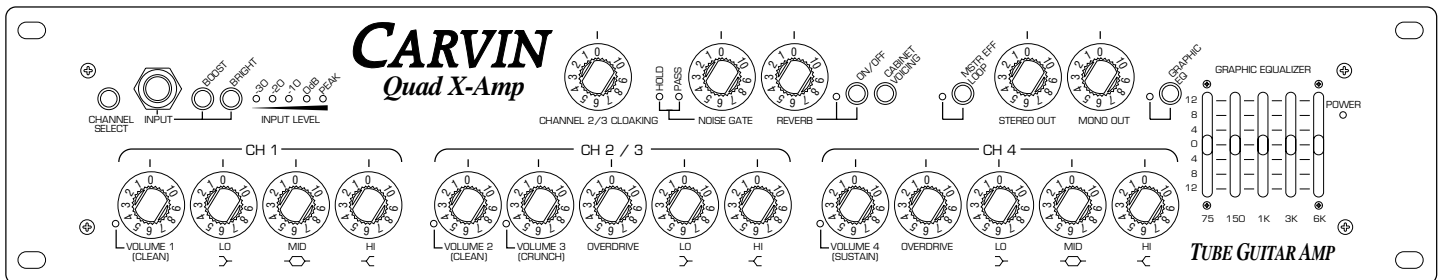

# CARVIN

## Quad X-Amp TUBE GUITAR PREAMP

### User's Guide

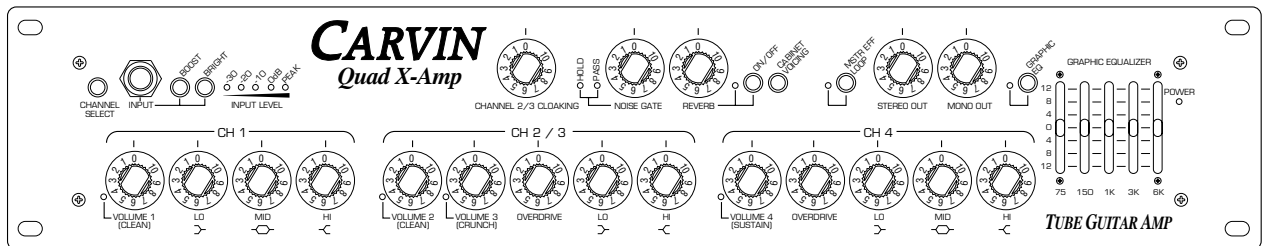

## The Quad X-Amp User's Guide

© 1993 by Carvin Corp.  
All Rights Reserved

No part of this manual may be reproduced  
without explicit written permission from  
Carvin.

Carvin, Quad X-Amp, QuikGate, Cabinet  
Voicing, and Tube Cascade are trademarks  
of Carvin Corp.

# Table of Contents

Section	Description	Page
	Table of Contents .....	iii
	Quick Start Sheet .....	vi
	Receiving Inspection .....	vii
	For the New Owner .....	viii
<b>1</b>	<b>Introducing the Quad X-Amp .....</b>	<b>1-1</b>
	1.0 Rip Like a Hurricane . . .With the Quad X-Amp .....	1-1
	1.1 Your Amp Had an Accident .....	1-2
	1.2 Designer Overdrive .....	1-2
	1.3 A Place for Everything .....	1-2
	1.4 Four Channels Up Front and a Stereo Back End .....	1-2
	1.5 Long Tailed Reverb .....	1-3
	1.6 From Rip City to Dead Silence .....	1-3
	1.7 Cloak Your Bottom .....	1-3
	1.8 Construction by Carvin .....	1-3
	1.9 EQ Lives in the Quad X-Amp .....	1-4
	1.10 There's Even More! .....	1-4
<b>2</b>	<b>Front Panel Control Descriptions</b>	
	2.0 The Control Layout .....	2-1
	2.1 The Input Control Group .....	2-1
	2.2 The Channel 1 Control Group .....	2-2
	2.3 The Channel 2 and Channel 3 Control Group .....	2-2
	2.4 The Channel 4 Control Group .....	2-3
	2.5 The Noise Gate .....	2-4
	2.6 Reverb, Cabinet Voicing and Master Effects Loop .....	2-5
	2.7 Master Level Controls .....	2-6
	2.8 The Graphic Equalizer .....	2-6
<b>3</b>	<b>Rear Panel Connections</b>	
	3.0 The Connector Layout .....	3-1
	3.1 Power Switch, Line Selector, and Fuse .....	3-1
	3.2 The FS-77 Footswitch Connector .....	3-1
	3.3 MIDI Interface Connections .....	3-2
	3.4 The Channel Effects Loops .....	3-2
	3.5 The Stereo Reverb Effects Loop .....	3-2
	3.6 The Master Effects Loop .....	3-2
	3.7 The Stereo Output Connectors .....	3-2
	3.8 The Balanced Mono Output .....	3-2
	3.9 The Ground Lift Switch .....	3-3
	3.10 The Stereo Headphone Jack .....	3-3
	3.11 The Rear Panel Input Jack .....	3-3

---

Section	Description	Page
<b>4</b>	<b>Using the <i>Quad X-Amp</i></b>	
	4.0 Power Amp Selection .....	4-1
	4.1 Speaker Selection .....	4-1
	4.2 Interconnecting the System .....	4-2
	4.3 Balancing the System Level Controls .....	4-2
	4.4 Effects Suggestions .....	4-3
	4.5 Recommended Settings .....	4-3
	4.6 Connecting to Another Guitar Amp .....	4-3
<b>5</b>	<b>The <i>FS-77</i> Footswitch</b>	
	5.0 About the <i>FS-77</i> Footswitch .....	5-1
	5.1 Connecting the <i>FS-77</i> Footswitch .....	5-1
	5.2 Using the <i>FS-77</i> Footswitch .....	5-2
<b>6</b>	<b>About Tubes</b>	
	6.0 A Brief History of Tubes .....	6-1
	6.1 Tubes, Amps, and Overdrive .....	6-1
	6.2 The Tube Cascade™ .....	6-2
	6.3 Tube Maintenance and Troubleshooting .....	6-3
<b>7</b>	<b>Using the MIDI Interface</b>	
	7.0 About the <i>Quad X-Amp</i> MIDI Interface .....	7-1
	7.1 Setting MIDI Channels .....	7-1
	7.2 MIDI Patch Configuration .....	7-2
	7.3 Making MIDI Connections .....	7-3

## Appendices

<b>A</b>	<b>Technical Specifications</b> .....	A-1
<b>B</b>	<b>Warranty Information</b> .....	B-1

---

---

# Quick Start Sheet

If you're like most new owners, you're probably in a hurry to plug in your preamp and get started using it. Before you plug it in, make sure the power switch is turned off and **read at least this page**.

## 1. Plug in the Preamp

- The amp is set for 120 VAC operation as shipped from the factory. If you are outside the United States and you are on 240 VAC power then you must change the setting of the AC line voltage selector built into the power cord connector at the rear panel. Change the power setting to 240 VAC by removing the fuse holder and turning it so that it reads 240 VAC right side up.
- Connect the preamp to a power receptacle using the grounded (3 conductor) cord provided.

## 2. Connect the Preamp to a Power Amplifier

- Unless you want to use the preamp with headphones only, it will be necessary to connect the preamp to a power amplifier in order to use it with loudspeakers.
- Connect the preamp outputs (mono or stereo) to the input of your power amplifier using a shielded cable. You can use either the 1/4" or XLR connectors.

## 3. Connect the Power Amp to your Speakers

- Use a speaker cable to connect the output of the power amplifier to input of the speaker.

## 4. Set the Controls to Normal

- At the top row of controls:
  - Set the CLOAKING, NOISE GATE, and REVERB controls at "0" to start.
  - Set the STEREO OUT and MONO OUT controls at "0". You'll set the volume here.
  - Set the BOOST, BRIGHT, and CABINET VOICING switches to OFF
- At the bottom row of controls:
  - Set VOLUME 1, VOLUME 2, VOLUME 3, and VOLUME 4 at "3".
  - Set all tone controls at "5" (LO, MID, HI : LO, HI : LO, MID, HI)
  - Set the two OVERDRIVE controls at "5".
  - Set all GRAPHIC EQUALIZER sliders at "0" or center position

## 5. Connect the Footswitch

- Connect the FS-77 footswitch cable to the "D9" connector on the rear panel. For a temporary setup it is not necessary to screw in the "D" connector screws. For a performance setup you may want to screw the connector in place to make sure that it isn't accidentally disconnected during the show.

## 6. Turn On the Preamp and the Power Amp.

- Switch on the *Quad X-Amp* (at the rear), and then switch on the power amplifier. Raise the power amplifier input level controls to between half and full on.

## 7. Plug In and Play

- Plug your guitar in at the front (or rear) input jack.
- Turn up either the STEREO OUT or the MONO OUT controls to set the volume. Set your volume with these master level controls—not with the channel VOLUME controls.
- Select the different channels either by using the footswitch or at the front panel by using the switch next to the input jack. Note that Ch3 is designed for only moderate, crunch, overdrive.
- Activate the noise gate by raising the control until the red HOLD light stays on.
- Raise the REVERB level if you wish.

## Receiving Inspection

**INSPECT YOUR AMP FOR ANY DAMAGE** which may have occurred during shipping. If any damage is found, notify the shipping company and call CARVIN immediately.

**SAVE THE CARTON & ALL PACKING MATERIALS.** In the event you have to reship your amp, always use the original carton and packing material. This will provide the best possible protection for your unit during shipment. CARVIN and the shipping company are not liable for any damage caused by improper packing.

**SAVE YOUR INVOICE.** It will be required for warranty servicing of your unit. Always check your invoice against the items you have received.

**SHIPMENT SHORTAGE.** If you find items missing, it may be that they were shipped separately. Please allow several days for the rest of your order to arrive before inquiring. If you determine (after allowing an appropriate amount of time) you have not received all the items you ordered, please call CARVIN.

## For the New Owner

Congratulations on your purchase of Carvin's *Quad X-Amp*! Your new guitar preamp is representative of Carvin's commitment to excellence in designing and producing the finest musical instrument products available today. The wide use of our products by well known artists illustrates Carvin's recognition as "The Professional's Choice."

Professionalism can only be measured by the results people achieve through their efforts and knowledge. It is not something that automatically happens when buying a new or more sophisticated amp. Rather, it's what you do with the equipment and how well you do it that ultimately makes the point. We are certain your new *Quad X-Amp* will deliver the performance necessary for you to achieve solid results, and ultimately enjoy a high degree of professional achievement and enjoyment.

To compliment your new *Quad X-Amp* and help you acquire that knowledge, we've included this manual. All of the information you need to be up and running is right here! You'll find that using this manual is easy and convenient. We've attempted to present the technical aspects of your new preamp accurately and in "plain English". But, if you have any questions that are not answered here, please call us at our toll free number. Our sales staff is well versed in the technical aspects of our products and is waiting to assist you with any questions you may have. We sincerely wish to ensure your complete satisfaction with your new preamp.

If you would like to comment on features or performance of your new preamp, please feel free to contact us. Comments from our customers have helped us improve and further develop our products and our business. We sincerely welcome any comments or ideas you may have.

Please, send in the warranty card. It will allow us to better know how you are using our equipment while maintaining an accurate reference in our files. Sending in the warranty card also allows us to mail out literature and information that may be of interest to you as a professional musician. Let us know where you are so we can keep in touch!

In this manual there are plenty of diagrams and descriptions to help you use your new preamp. So, with this manual in hand, you hold the key to proper operation of your new *Quad X-Amp*, and to achieving truly professional results.

May you have many years of enjoyment, success, and fun with your new Carvin preamp!

**Carvin's national toll free number: 800-854-2235**

Section

1

Introducing the *Quad X-Amp*

**1.0 Rip like a Hurricane . . . with the *Quad X-Amp***

Carvin’s new *Quad X-Amp* is not only the hottest guitar preamp ever designed, it’s also incredibly easy to use. Four channels are only the beginning . . . This outrageous new preamp beats anything you’ve ever heard before. From crystal clean to tube crunch to full ripping sustain this amp has all the sounds. There are no weird mystery commands to remember, just straightforward vintage controls that you already know how to use. Well . . . aaa . . there is the cloaking device . . .

	CHANNEL 1	CHANNEL 2	CHANNEL 3	CHANNEL 4
Crystal Clean Sound	•	•		
Tube Crunch			•	
Tube Cascade Sustain				•
Active Tone Controls	•	•	•	•
Cloaking Filter		•	•	
Reverb				
w/ Select Memory	•	•	•	•
Channel Effects Loop	•	•	•	•
Master Effects Loop				
w/ Select Memory	•	•	•	•
Graphic EQ				
w/ Select Memory	•	•	•	•
Noise Gate	•	•	•	•
MIDI Selectable	•	•	•	•
External Stereo Reverb Loop				
w/ Select Memory	•	•	•	•
Boost and Bright Switches	•	•	•	•

**Features of the *Quad X-Amp***

## 1.1 Your Amp had an Accident

Most tube amps have a decent overdrive sound only by accident. That's right, by accident. Those vintage Fender and Marshall amps were never designed to be used for overdrive. Players in the '60's turned there amps up too far and found a new sound. Most amps have changed very little since then. Check the history books. It's true.

## 1.2 Designer Overdrive

Here's a crazy idea . . . What if somebody actually *tried* to design a tube amp for the wildest overdrive sound ever imagined? Well now they have, it's called the *Quad X-Amp* and it's only available from Carvin.

Designed to be the ultimate guitar tone generator the *Quad X-Amp* provides powerful new tone generation circuits. Ever heard of the **Tube Cascade™**? Not yet maybe, but you will . . .

Carvin's newly designed **Tube Cascade™** circuit milks all the tone possible out of those little glass goodies called tubes. Imagine a zillion lightning bolts shredding the night sky and powering you through your next gig. You have to hear this amp.

## 1.3 A Place for Everything — 6 Effects Loops!

Let's face it, the guitar effects that were hip yesterday probably won't be so cool tomorrow. (time to dust off your wah-wah pedal again) Trendy effects just don't belong in your amp, they belong outboard where you can swap them out as the trend or your own style changes. The *Quad X-Amp* gives you access to all the effects in the world without committing you to any of them. That's as it should be for an amp designed to take charge.

To make this happen the *Quad X-Amp* has six effects loops: One loop for each channel, one stereo reverb side chain loop and one stereo master in-line loop. The reverb and master loops are controlled via footswitch or front panel and their settings are remembered by the channels.

## 1.4 Four Channels up Front and a Stereo Back End

Four independently selectable channels (two clean and two overdrive) feed a stereo master section to give you full access to stereo reverbs, stereo chorus effects etc. The stereo reverb loop can be used to replace the internal mono reverb. The switchable master stereo loop lets you connect in-line stereo effects like a stereo chorus for example. Each channel remembers whether the reverb and master loops are on or off for that channel. Each channel has it's own dedicated effects loop so that you can customize the sound of each channel as much as you like.

## 1.5 Long Tailed Reverb

Most guitar amps will cut off the tail of your reverb when you switch the reverb off. How rude! The *Quad X-Amp* handles your reverb more delicately. The reverb on/off switch (footswitch or front panel) switches only the reverb “send” leaving the tail of the reverb to decay naturally, the way you do it in the studio. After all, you expect studio performance from a studio grade amp.

## 1.6 From Rip City to Dead Silence

The problem with most rigs running full sustain is that if you mute the guitar the noise is deafening. The *Quad X-Amp* goes from rip city to dead silence the moment you stop playing. It’s not quite magic but it is our new *QuikGate*<sup>TM</sup> integrated noise gate system. Set it once and leave it. Even if you switch channels or adjust the overdrive, *QuikGate*<sup>TM</sup> needs no further adjustment. *QuikGate*<sup>TM</sup> takes it’s direction from the very front end of the preamp but mutes the back end to eliminate all the noise . . . especially the noise that comes with super high gain overdrive. A pair of LED’s let you know what’s going on.

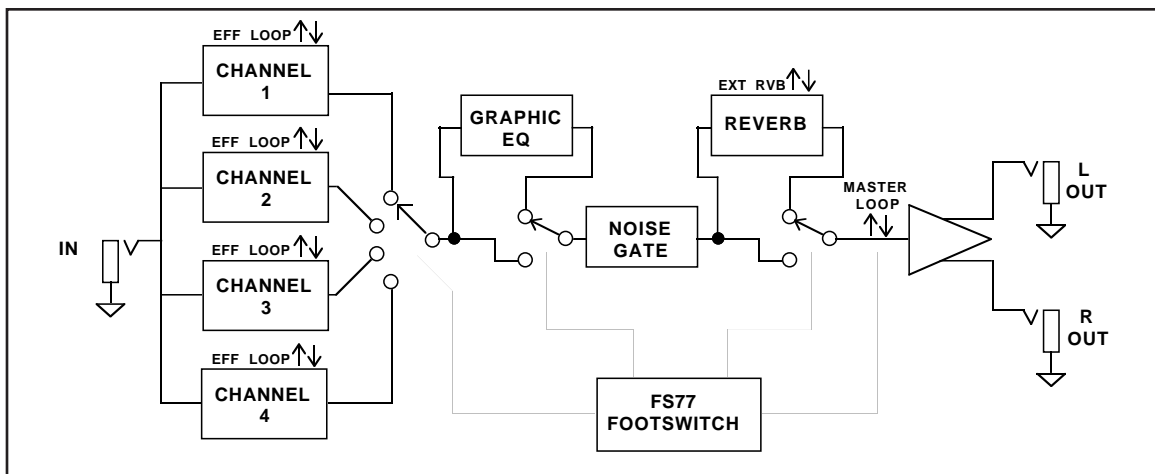

**Simplified Block Diagram**

## 1.7 Cloak Your Bottom

No, it doesn’t make the preamp disappear . . . but it does make the bottom range of your guitar disappear. The Cloaking filter prevents mid-bass buildup in the mix. Use it to shut up the keyboard player when he says you’re stomping on him.

## 1.8 Construction by Carvin

It’s built first class. Anodized aluminum front panel, steel chassis, high quality double sided circuit boards, premium components, select tubes, etc. Need we say more?

## 1.9 EQ Lives in the Quad X-Amp!

Are you tired of dead tone controls? You know, the kind where you can turn the mid up to 10 and then down to 0 and you can barely hear any difference. That's passive EQ for you; it's very simple, very cheap, and very dead. Who needs it! Carvin's classic X-Amp first showed how a powerful active EQ can shape guitar tone. Now the *Quad X-Amp* gives you not one, but **three** sets of active EQ tone controls. Channels 1 and 4 each have their own dedicated three band EQ while channels 2 and 3 share a two band EQ and the cloaking filter. If that's not enough, the five band graphic EQ can be assigned to any of the channels and the amp will remember which channels use the graphic and which don't. If that's still not enough, you can patch an outboard EQ into any of the channel's effects loops. Now that's EQ!

## 1.10 There's Even More!

When players asked us to make the best possible guitar amp they forgot to say stop . . . so we kept on going with all the finishing touches. We added an input level display to let you know if you need to use the input boost control. Strat players have always *needed* a boost switch for full overdrive, and now they've got it. Since most guitars either need a bright boost or they don't, the *Quad X-Amp* has a single master bright switch.

Recording direct to the mixer has never been too popular with guitar players because they would lose the characteristic sound of their speaker cabinets. Not any more! Punch the **Cabinet Voicing™** switch, patch straight into the mixer, and you have the sound of the *Quad X-Amp* playing through a 4x12 stack. Our Cabinet Voicing circuitry precisely models the low frequency response of a vintage stack as driven by a tube power amp. But we don't stop there, we also dial up the high end response of the stack for total realism.

## Section

## 2

## Control Descriptions

## 2.0 The Control Layout

The *Quad X-Amp* is a four channel amplifier where only one channel is active at any given time. There is nothing mysterious about its operation. The top row of controls are master controls that affect the overall operation (all channels) of the amp. The controls in the bottom row are grouped by channel and affect only their individual channel. The only exception is the CLOAKING control which is in the top row but affects only channels 2 and 3.

## 2.1 The Input Control Group

### The Channel Select Switch

Push this switch to select through the four channels. Even when the FS-77 footswitch is used you can still change channels from the front panel.

### Guitar Input Jack

Plug your guitar in here. Using the front panel input defeats the rear input.

### The BOOST Switch

If you are using a guitar with a low output level push the boost switch for 10dB of additional input gain. If the red LED flashes then make sure the boost switch is out.

### The BRIGHT Switch

Use the bright switch when you need a treble boost. Most guitars either need it or they don't. The bright switch will emphasize the pick sound and attack of overdrive because it's pre-distortion. For a smoother overdrive tone leave the BRIGHT switch off.

### Input Level Display

The input level display should be used to set the boost switch. If you are not seeing at least one of the green LED's coming on regularly as you play then you should use the boost switch to increase the input gain. If the red LED comes on then the boost should not be used.

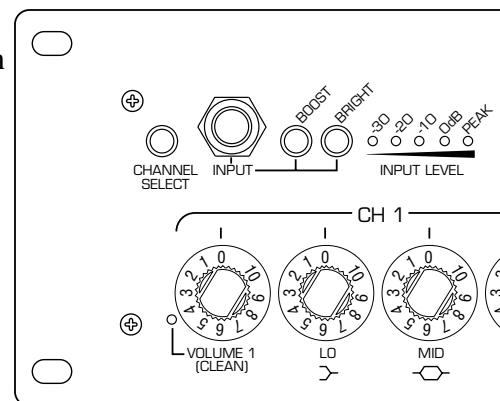

## 2.2 The Channel 1 Control Group

### The Channel 1 LED and Volume Control

The Ch 1 LED lights whenever Ch 1 is active. Use the VOLUME 1 control to set the level of channel 1 relative to the other channels. The normal setting of each channel volume is "3". To adjust your volume always use either the Stereo (or Mono) Master level control at the far right of the top row of controls. As a rule, you should always set the master volume higher than the channel volume controls.

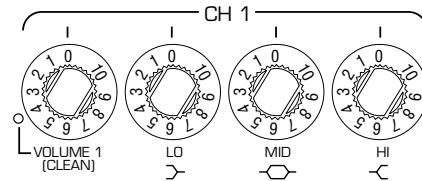

### LO, MID, and HI Tone Controls

These three tone controls let you adjust the bass, middle and treble tone balance for channel 1. Like all the controls in this group they affect only this channel. The normal (flat) setting is "5" for each control. Be careful though, all the tone controls on the *Quad X-Amp* are quite powerful; use them sparingly. Unlike amps with passive tone controls, starting out with all the tone controls at "10" would be a mistake.

## 2.3 The Channels 2 and 3 Control Group

### Channel 2 LED and Volume Control—for CLEAN

The LED next to the VOLUME 2 control lights whenever Ch 2 is selected. Use the VOLUME 2 control to set the level of channel 2 relative to the other channels. The normal setting is "3". Adjust your overall volume using the STEREO OUT control at the far right of the top row of controls.

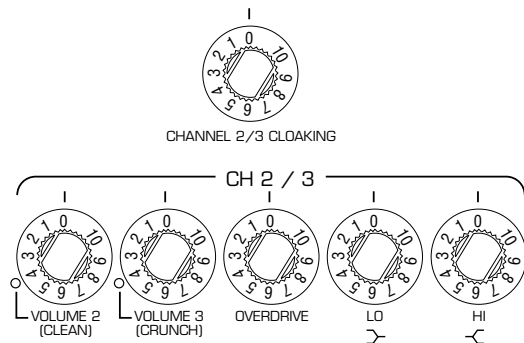

### Channel 3 LED and Volume Control—for OVERDRIVE

The LED to the left of the VOLUME 3 control lights whenever channel 3 is the active channel. Use VOLUME 3 to set the level of channel 3 relative to the other channels. The normal setting is about "3". If you use the overdrive control set low you will probably need to raise the Ch 3 volume a little higher to make up for the light overdrive level. If you prefer the overdrive set high then you will need a lower setting of the Ch 3 volume to match the volume of the other channels. Experiment! Remember though, adjust your overall volume using the STEREO OUT or MONO OUT control, not at the channel volume.

### Channel 3 Overdrive Control

The Channel 3 Overdrive control sets the drive level for the "crunch" channel. Although you can use it for overdrive, channel 3 is designed with less drive and a brighter voice than channel 4 specifically to allow you to get a sound in between clean and distortion. What we call a "crunch" sound. Try setting the overdrive level so that you can stay clean with a light touch but can get a definite crunch out of power chords. For full on overdrive you'll probably want to use channel 4.

### LO, and HI Tone Controls

These two tone controls let you adjust the bass and treble tone balance for channels 2 and 3. They affect only channels 2 and 3. The normal (flat) setting is "5" for each control. Be careful though, all the tone controls on the *Quad X-Amp* are quite powerful; use them sparingly. Unlike amps with passive tone controls, starting out at "10" would be a mistake. If in doubt return to settings near "5".

### Channel 2 /3 Cloaking Control

The cloaking device! There is no "normal" setting for the cloaking filter but setting it to "0" will defeat it. As you raise the control it will begin "cloaking" the bottom range of your guitar until at "10" only the very high end remains. The best way to learn what this control does is to listen to it. It affects both channel 2 and channel 3 so that you can use it for both clean and overdrive playing. It's especially useful for thinning out your recording mixes.

## 2.4 The Channel 4 Control Group

### Channel 4 LED and Volume Control

The LED next to the VOLUME 4 control lights whenever Ch 4 is selected. Use the VOLUME 4 control to set the level of channel 4 relative to the other channels. The normal setting is "3". Adjust your overall volume using the STEREO OUT control at the far right of the top row of controls.

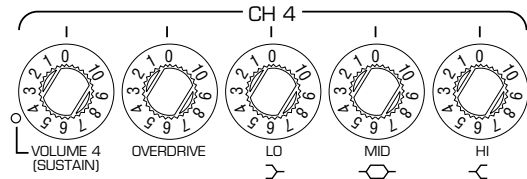

### Channel 4 Overdrive Control—for Sustain

The Channel 4 Overdrive control sets the drive level for the "sustain" channel. Set the overdrive level for the drive character and sustain time you like. Higher settings give longer sustain times and stronger tendency to feed back, but they also give you higher noise. For high drive settings we recommend that you use the noise gate. You should definitely experiment with the full range of this control. Listen to the way the tone changes as a note decays. This tone modulation changes with the overdrive setting. Don't feel like the only setting for the overdrive is "10" or you may miss the subtle variations in the overdrive voice that are available at lower settings.

### LO, MID, and HI Tone Controls

These three tone controls let you adjust the bass, middle and treble tone balance for channel 4. Like all the controls in this group they affect only this channel. The normal (flat) setting is "5" for each control. Be careful though, all the tone controls on the *Quad X-Amp* are quite powerful; use them sparingly. Starting out with all the tone controls at "10" would be a mistake.

## 2.5 The Noise Gate

The *QuikGate*<sup>™</sup> noise gate circuit built into the *Quad X-Amp* is unlike any other noise reduction device you could add to your guitar rack because it is *integrated* into the preamp rather than just "tacked on". Even when you have the overdrive channel selected *QuikGate* still sees the full dynamic range of the undistorted input signal and takes its cues from the dynamics of that signal. Under the same conditions any external noise gate would only have the distorted signal to work with (a signal with almost no dynamic range) and would be doomed to poor gating action, regardless of the quality of the product, simply because of the point at which it was inserted in the signal chain. *QuikGate*, being built into the preamp, has this unique advantage over any outboard noise gate regardless of price or "wonderfulness". Try it, especially with overdrive, and you'll know instantly what we mean.

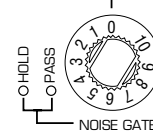

To use the *QuikGate* system start with your guitar plugged in and then simply raise the setting of the NOISE GATE control until the LED just changes from PASS to HOLD. This lets you know that the circuit has just muted the output of the preamp. As soon as you play a note the display will change from HOLD back to PASS to allow the signal through the preamp. When you stop playing the display changes back to HOLD and any noise will be muted by about 30dB. The setting of the noise gate (threshold) control does not depend on which channel is selected and its action will remain constant from channel to channel. This lets you set it once and then forget it. This is one of the ways the *Quad X-Amp* helps you concentrate on you playing instead of your gear.

### Noise Gate Application Hint

As with any noise gate, *QuikGate* will momentarily gate on in response to any sound from your instrument. You can set the control a little higher to reduce this "false gating" but setting the control too high will cause the decaying "tail" of long sustained notes to be cut off prematurely. The best results are usually obtained by setting the control just high enough to gate off and then adapting your playing technique to minimize any false gating.

## 2.6 Reverb, Cabinet Voicing, and Master Effects Loop

### Reverb On/Off Switch, LED, and Level Control

The *Quad X-Amp* has a built in spring reverb with a uniquely flexible control system. The front panel pushbutton switch can be used to toggle the reverb on and off as indicated by the red LED located between the switch and the reverb level control. Use the level control to set the amount of reverb you desire. You can also switch the reverb on and off using the FS-77 footswitch. LED indicators at both the front panel and the footswitch always show the current status of the reverb. Each of the four channels will remember its reverb status and switch the reverb on or off when each channel is selected.

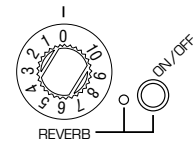

### How To Use the Reverb Memory Feature

When you first power up the amp the settings of the reverb is "on" for all four channels. (this can vary depending on how long the unit was off) Set the reverb "on" for channels 1 and 3 and "off" for channels 2 and 4 as follows.

- Select channel 1 and switch the reverb "ON".
- Select channel 2 and switch the reverb "OFF".
- Select channel 3 and switch the reverb "ON".
- Select channel 4 and switch the reverb "OFF".

Now select among the channels and you'll see the reverb switches "ON" whenever channels 1 or 3 are selected. The reverb switches "OFF" whenever channels 2 or 4 are selected.

You can turn the reverb on/off at any time and the preamp will remember the setting for each channel. What could be easier!

Most guitar amps simply switch off the reverb return when you switch the reverb off. That's OK for practicing in your bedroom, but for studio work or professional level performances it's really tacky to just chop off the tail of the reverb. The reverb switch in the *Quad X-Amp* controls the reverb *send* rather than the return. This provides studio quality switching where the reverb is allowed to decay naturally. Let's hear it for long tailed reverb!

For the ultimate in stereo reverb effects the *Quad X-Amp* has a stereo reverb effects loop that works with the front panel controls just like the internal (mono) reverb. Just patch your external reverb in at the send and return jacks at the rear panel and the internal reverb will be defeated and replaced by your stereo unit. For the best results set your external reverb for 100% reverb (no direct sound) and control the reverb level from the front panel using the REVERB control. We recommend that you follow through by using the stereo outputs, a stereo power amp, and stereo speakers.

The reverb effects loop can also be used with other stereo effects such as echo units or digital delays. You can also use mono effects in the reverb loop. If in doubt try it!

### The Cabinet Voicing Switch

This switch inserts Carvin's **Cabinet Voicing™** circuit to add the frequency response coloration of a 4x12 guitar speaker stack. This effect is intended to be used whenever you are not playing through "guitar speakers". Use it when recording direct to the mixer, practicing with headphones, or playing over full range speakers (such as studio monitors). It's not recommended for use with guitar speakers.



### The Master Effects Loop Switch and LED

Use this switch to toggle the master effects loop on and off. The LED indicates the status of the master effects loop. You can also switch the master effects loop on and off using the FS-77 footswitch. LED indicators at both the front panel and the footswitch always show the current status of the master effects loop. Each of the four channels will remember its effects status and switch the loop on or off when each channel is selected.



## 2.7 Master Level Controls

### Stereo Out and Mono Out Level Controls

Use these controls to set the overall volume at the stereo and mono outputs. If your power amplifier has input level controls then you should set those controls between maximum and half to make sure that the power amp gets to maximum power well before the preamp does. Set the actual playing volume using the master level controls while using the individual channel volume controls only to balance the volume between the channels.

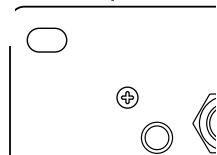

## 2.8 The Graphic Equalizer

### The Graphic Equalizer, Bypass Switch, and LED Indicator

The five band graphic EQ employs a bypass switch with the same memory recall feature as the reverb and master effects loop. The LED indicator at the front panel (and the one at the footswitch) always shows the current status of the graphic EQ. Each of the four channels will remember its graphic EQ status and switch the EQ on or off as each channel is selected. This allows you to assign the graphic EQ to some channels and not to others. The normal settings of the EQ sliders is the center (detent) position. When in doubt about the setting try returning the sliders toward the center position.

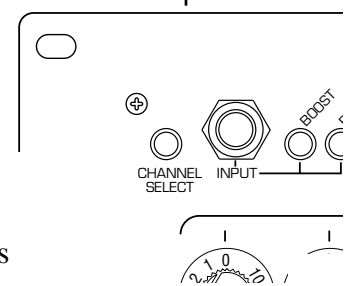

Each slider acts as a volume control for a relatively narrow range of pitch. What matters is the differences in position. Boosting (or cutting) all bands the same amount would simply result in a volume adjustment.

Section

3

# Rear Panel Connections

## 3.0 The Rear Panel Layout

The rear panel is organized with power switch and line cord connector at the far left. The connections from left to right are: footswitch, MIDI control, channel effects loops, master effects loops, preamp outputs, and input.

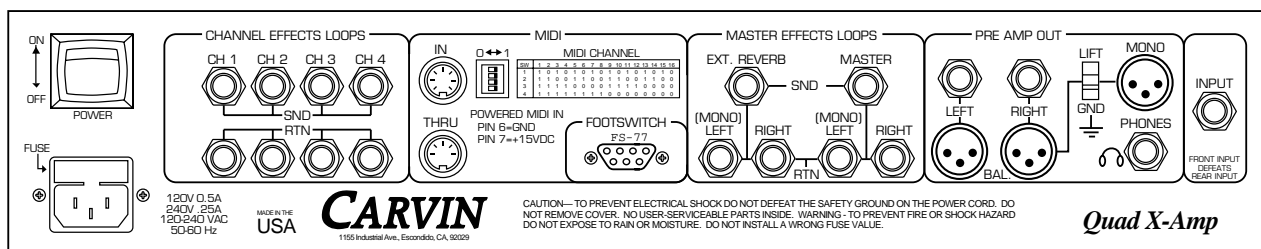

## 3.1 Power Switch, Line Selector, and Fuse

Use the power switch to turn the preamp on and off. Even though the *Quad X-Amp* is a tube preamp, it does not require a standby switch because it does not use the high power tubes required for power amps. Rather, the *Quad X-Amp* uses 12AX7 tubes which run fairly cool and have a very long life.

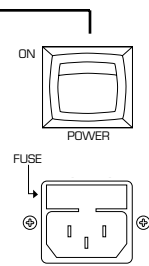

**How to Set the Amp for 240VAC Power**

The fuse and the 115/230volt line switch are built into the AC line cord connector. To set the amp to operate from 230VAC (50 or 60 Hz) power first unplug the power cord and remove the fuse holder. Turn the fuse holder over and insert it so that it reads 230V right side up. The amp is now set to operate from 230 VAC.

**Fuse Values: 120 VAC : 1/2 Amp  
240 VAC : 1/4 Amp**

## 3.2 The FS-77 Footswitch Connector

This D-9 connector is used to attach the FS-77 footswitch. Connect and disconnect the footswitch only when the power is turned off. Connect no other cables here as the *Quad X-Amp* employs power supply voltages that could damage other gear if inadvertently connected here.

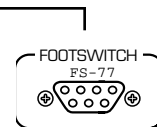

### 3.3 MIDI Interface Connections.

Use the MIDI interface to control the *Quad X-Amp* remotely with a MIDI footswitch or other MIDI control device. The unit is equipped with both a MIDI IN and a MIDI THRU to allow you to chain together multiple MIDI devices. For information on setting up and using the MIDI features see section 7.0.

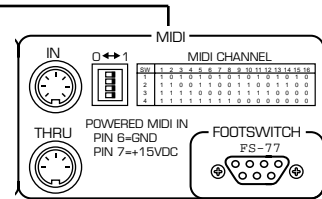

### 3.4 The Channel Effects Loops

Use the channel effects loops for effects devices that you want to use on just one channel. Each channel of the amp has its own dedicated effects loop. This is one of the features the *Quad X-Amp* has that sets it apart from the competition. The signal level in each loop is at instrument level (-10dBv). The effects loops are pre (channel) volume and pre tone controls. The effects loops on channels 3 and 4 are pre overdrive, but each channel loop can be switched to post overdrive by changing jumpers on the channel master circuit board. (This change should only be done by a competent amp technician.)

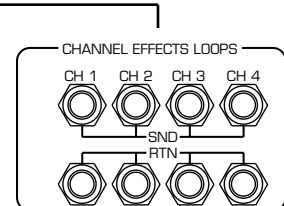

### 3.5 The Stereo Reverb Effects Loop

Use the stereo reverb loop to patch in your favorite stereo reverb. Set your reverb to 100% effect. Then use the front panel reverb control to set the overall reverb level. The external reverb will follow the reverb switching assignment for each channel. Using these return jacks automatically defeats the internal reverb. For mono effects, use the left input only.

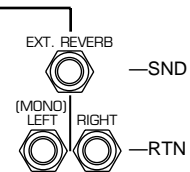

### 3.6 The Master Effects Loop

Use this loop for effects devices that you want to use on more than one channel. This loop uses a mono send and a stereo receive so you can fully exploit your stereo effects units. The loop can be switched on and off from the front panel or from the footswitch. Each channel remembers it's own setting. For mono effects, use the left input only.

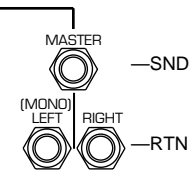

### 3.7 The Stereo Output Connectors

The stereo outputs normally connect to the input of a stereo power amplifier. The level here is controlled by the STEREO OUT control on the front panel. The 1/4" connectors are convenient for short patches. For longer cable runs (such as stage to mixer), and for lowest noise performance when recording direct, use the balanced outputs.

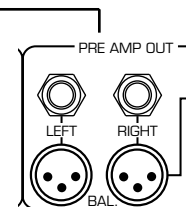

### 3.8 The Balanced Mono Output

Use the mono output for single channel operation. This output is also useful as an auxiliary output to the P.A. system or a recorder where a separate level control is useful. The level here is controlled by the MONO OUT control on the front panel.



### 3.9 The Ground Lift Switch

Set this switch for the lowest noise when using either the stereo or mono balanced outputs. When the switch is in the lift position it breaks the connection to pin 1 which is normally grounded. This breaks any ground loops between the preamp and the gear it's feeding.

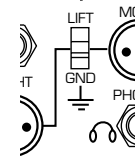

### 3.10 The Stereo Headphone Jack

Use the stereo headphone jack for private practice or whenever you wish to use phones. The level at the stereo phone jack is controlled by the stereo out control on the front panel.



### 3.11 The Rear Panel Input Jack

Use the rear panel input jack when you need to connect to the input of the *Quad X-Amp* from another piece of gear in your rack. The rear input feeds the normal connection at the front input jack. When a plug is inserted in the front jack, it overrides the rear input. Only one input jack can be used at a time.

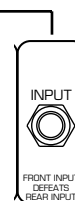

## Section

## 4

Using the *Quad X-Amp***4.0 Power Amp Selection**

We highly recommend a stereo power amplifier (such as Carvin's FET 450 or FET 1000) for use with the *Quad X-Amp*. The power rating will depend on the speakers you use but a reasonable minimum rating would be 100 Watts continuous per channel into 8Ω.

**Speaker Power vs. Amp Power**

Don't feel like you have to "match" the rating of the power amp to the rating of the speaker. That's not the case at all. The speaker's power rating is the maximum power that the speaker can take before it is damaged. As a rule, you could never continuously deliver your amps full rated power into your speaker without grossly overdriving the amp. In reasonable use you will only reach full power on peaks. Even as you begin to overdrive (clip) your amp on musical peaks the average power to your speakers will only be about one tenth of the amp's rated power. The average power input is what matters to your speakers. Allowing for exaggerated speaker power handling claims, and for frequent clipping, you can still safely use an amp rated at twice the power of the speaker. So don't skimp on amplifier power.

**4.1 Speaker Selection**

The most popular speakers among guitar players are 12" "full range" speakers in various open back and sealed enclosures. Any of these systems will provide adequate performance for most players. Of the currently popular enclosures the one that seems best suited for a stereo setup is the 2x12 sealed enclosure. An excellent example of this speaker format, and one that we recommend, is Carvin's V212 system. Where higher sound levels are required you might consider one 4x12 system for each of the left and right channels. Double 4x12 stacks on each side would provide even higher sound levels.

## 4.2 Interconnecting the System

Once you have selected your power amp and speakers interconnect is straightforward. Start with all the gear turned off. Connect the outputs of the *Quad X-Amp* to the inputs of the power amp. Although you can use either the 1/4" or the XLR connectors, for the lowest noise we recommend using the balanced XLR connections both at the preamp output and at the power amp input. This completes the preamp to power amp connections.

Next connect the power amp left and right outputs to the inputs of the left and right speakers. Make sure you use heavy gauge wire for all your speaker connections, no lighter than 16 gauge.

Now you are ready to power up the system. Make sure the input level controls on the power amp are set to minimum. Set the STEREO OUT and MONO OUT controls on the preamp to minimum. Now power up the system. First turn on the preamp, and then the power amp.

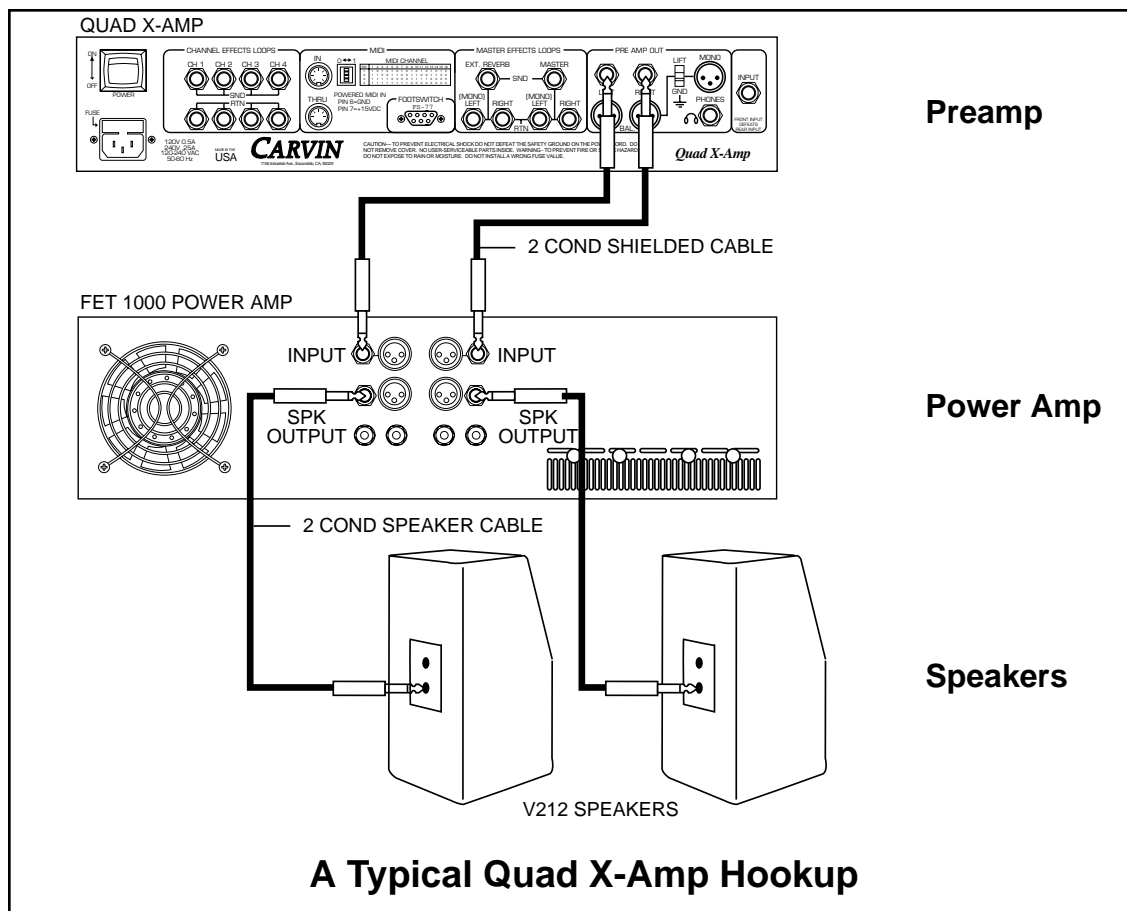

## 4.3 Balancing the System Level Controls

With this many level controls it's easy to get the system messed up. The best approach is to start with the power amp input level controls at maximum. Then set each of the channel volume controls at "2". Finally raise the STEREO OUT control for the volume you want. If you want a low volume level for practicing then you might back the power amp input level controls down to half. Setting the power amp input level controls less than half is not advised as you risk overdriving the output of the preamp before reaching full power.

### 4.4 Effects Suggestions

Now that you have your basic Preamp/Power Amp/Speaker setup let's start evaluating effects configurations.

#### Digital Multi-Effects Unit

You probably want to patch your most versatile multi-effects unit into the master effects loop so that you will have it available for use with any channel. Chorus, delay, and flanging effects will work great here.

#### Stereo Digital Reverb

Patch your stereo digital reverb into the reverb effects loop for a studio reverb sound in full stereo. Make sure you set the mix control to 100% effects.

#### Stomp Box Effects

Your floor effects boxes will work great in the individual channel effects loops. These four effects loops are always "on".

### 4.5 Recommended Settings

The table below contains some basic control settings that you might try.

Some Recommended Sounds and Settings													
Sound Description	Ch	B	M	T	Drive	Bright	Cloaking	Suggested Effects	Graphic EQ				
									75	150	1k	3k	6k
Clean jazz	1	8	7	3	-	off	-	any	0	+4	0	0	0
Clean, bright	1	5	4	7	-	on	-	chorus/flanger	0	0	0	0	+2
Clean, tight	2	5	-	5	-	off	6-7	slap back delay	0	0	0	+4	0
Crunchy jazz	3	7	-	5	4-7	off	0	any	+4	+2	0	0	0
Crunchy, bright	3	5	-	8	4-7	off	2-4	delay	0	0	0	0	+2
Crunchy, tight	3	5	-	5	6-10	off	5-7	reverb	0	0	0	0	0
Driven, mellow	4	7	5	4	3-6	off	-	any	+2	0	+4	0	-2
Driven, bright	4	5	3	7	5-7	off	-	chorus/flanger	0	0	0	0	+2
Driven, chunky	4	8	4	5	6-8	off	-	flanger	0	-4	0	0	0
Heavy full shred	4	8	6	5	8-10	off	-	any	0	+2	+4	0	+3

### 4.6 Connecting to Another Guitar Amp

There may be occasions when you wish to connect the *Quad X-Amp* to another guitar amp so that you can use that amp's power amplifier and speaker. In these situations we recommend that you connect the preamp output from the *Quad X-Amp* to either the power amp input or the effects return input of the other guitar amp in order to bypass that amp's fixed equalization circuits. The instrument input of the other guitar amp should only be used as a last resort because this would result in the other amp's fixed equalization being added to the fixed EQ used in the *Quad X-Amp*.

Section

5

# The FS-77 Footswitch

## 5.0 About the FS-77 Footswitch

The FS-77 footswitch is available as an optional accessory for the *Quad X-Amp* guitar preamp. With the footswitch you can easily control the most important functions of the amp from the stage while you are performing. An extra long 20 ft. cable allows you the freedom to place your rack on stage as you wish.

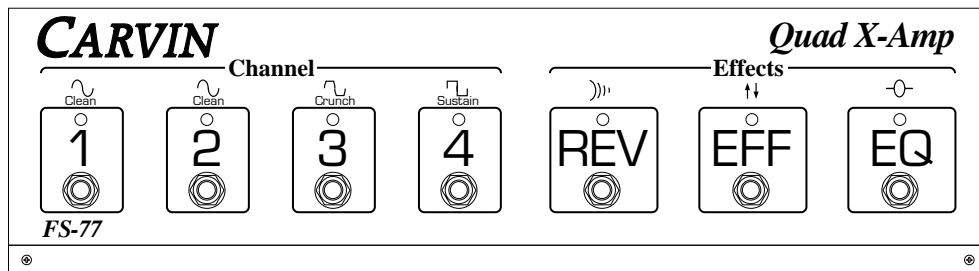

## 5.1 Connecting the FS-77 Footswitch

Make sure the preamp is switched off before connecting or disconnecting the footswitch. The D-9 data connector plugs into the footswitch connector at the rear panel of the *Quad X-Amp*. For performances we recommend that the plug be secured to the preamp using the retaining screws on either side of the connector. For casual practice it is not necessary to use the screws.

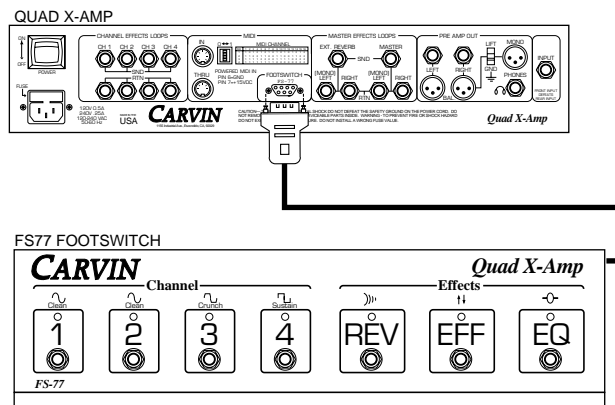

## 5.2 Using the FS-77 Footswitch

The footswitch allows you to directly access each of the four channels by depressing the footswitch button corresponding to the channel you want to use. As you change channels the system instantly configures the reverb, effects loop, and graphic EQ for that channel. Just set the reverb, effects loop, and graphic EQ as you like for each channel and then when you switch back to that channel each function will be set as you left it. The LED indicators at both the footswitch and the front panel are constantly updated to keep you informed of the system status. You can change any function at either the front panel or at the footswitch. Those players who use a MIDI footswitch to control their amp may want to also use the *FS-77* to have instant access to channels and effects without making a patch change at their other gear.

### Using the Effects Memory Feature

When you first power up the amp the effects are switched "ON" for all four channels. (this can vary depending on how long the unit was off) To demonstrate the effects memory feature of the amp try the following. Set the reverb "ON" for channels 1 and 3 and "OFF" for channels 2 and 4 by doing the following:

- A: Select channel 1 and switch the reverb "ON".
- B: Select channel 2 and switch the reverb "OFF".
- C: Select channel 3 and switch the reverb "ON".
- D: Select channel 4 and switch the reverb "OFF".

Now select among the channels and you'll see the reverb switches "ON" whenever channels 1 or 3 are selected. The reverb switches "OFF" whenever channels 2 or 4 are selected. The master effects loop and graphic EQ work the same way as the reverb.

## Section

## 6

## About Tubes

## 6.0 A Brief History of Tubes

The history of vacuum tubes began in 1883 when Thomas Edison discovered that the hot filament in his light bulb was boiling off electrons. This Edison effect (known today as thermionic emission) was to become the basis of the operation of the vacuum tubes that would lead to radio, television, radar, computers, and, oh yes . . . guitar amplifiers.

A short time later (1904), in England, John A. Fleming created the Fleming valve by inserting an extra electrode plate into a light bulb. Fleming discovered that electrons would flow in only one direction in his valve, from filament to plate. The filament boiled off electrons which then would readily flow towards the positively charged plate but resisted any flow back to the hot filament. Today we call such devices diodes or rectifiers. The Fleming valve was the first tube rectifier.

Two years later (1906), back in America, an inventor named Lee De Forest tried inserting a third electrode between the filament and the plate of a Fleming valve. This new electrode consisted of a fine wire mesh. De Forest found that a small voltage applied to the new grid electrode could control the flow of a relatively large current between the filament and the plate. The device had the effect of amplifying the signal applied to the grid and made possible the first radio broadcasts of speech and music. Lee De Forest called his invention an "audion"; today we call his device a tube triode.

De Forest's audion is the same basic tube amplifier stage used in the *Quad X-Amp* today. The 12AX7A tubes used in the *Quad X-Amp* are actually *dual* triodes. That is, there are two triode amplifiers in each tube. The nine pins on each tube are for the following connections: two plates, two grids, two cathodes, and three connections to the heater (filament).

## 6.1 Tubes, Amps, and Overdrive

The first guitar amplifiers used vacuum tubes as their sole means of amplification, simply because that was the only technology available at the time (1950's). Players first started overdriving their amps in the 1960's by turning the volume up until the amp distorted. The early amps were never designed to be played this way and the fact that they had an interesting tone

when overdriven was simply an accident. This meant that the only way to get distortion effects was to play at a very loud volume. Soon technicians discovered that they could add a master volume control between the preamp and the power amp stages of guitar amps in order to provide a volume control for the distortion effects. This let players turn up the preamp volume to get overdrive and then turn down the master volume control to set the overall loudness. Soon manufacturers added master volume controls to their amps, but the basic tube circuitry remained unchanged.

## 6.2 The Tube Cascade™

At the outset of the *Quad X-Amp* project we knew we wanted to do something new with tubes. We surveyed every significant tube guitar amp ever made and came to a surprising conclusion. They were all basically the same. Yes, they had their minor differences in features and packaging but by and large everybody had just copied the early Fender circuits. Most importantly, there was little new design work being performed on the actual overdrive sound. The overdrive sound of most amps was not much more than an accident. We were not content to simply place another Fender clone in pretty packaging along with some extra features.

We searched for the essence of the tube sound. Our earlier work had disproved the old truism that says "tubes produce even order harmonics and transistors produce odd order harmonics". That is a grossly simplistic view of the complex waveforms that can be produced by any overdriven circuit. The mathematical method of Fourier analysis readily predicts the harmonic structure of any waveform based on the shape of the wave. Using the method of Fourier analysis it can be shown that tubes can be used to produce either odd or even harmonics or combinations of the two, just as solid state circuits can. There is more to the tube overdrive phenomenon than that often repeated claim of odds versus evens.

### The Dance of the Harmonics!

Besides the ear, our primary tool for studying overdrive effects was a computer based spectrum analyzer. As we studied the tube overdrive spectrum closely we realized that we were seeing not only a mix of odd and even harmonics, but that the amplitudes of each of these two families of harmonics were alternately rising and falling with the attack and decay of each note. In addition, as each harmonic family would rise and fall a series of notches would sweep up and down through that family of harmonics. Not only was the harmonic structure rich in content but there was a lot of activity among the harmonics. In comparison, the harmonics from solid state circuits would just rise and decay with each note. These simple circuits had none of the harmonic agility of the tube circuits. There can be no doubt that this "harmonic dance" accounts for most of the audible differences between otherwise similar tube and solid state circuits.

Using the methods of Fourier analysis we then related the harmonic activity of the tube circuits to the modulation of the waveform that resulted from the coupling of at least two tube stages. Typical amps always used at least two coupled stages. It seemed that if the sound of 2 or 3 coupled stages was good, maybe a system with more complex coupling could produce a more complex harmonic dance and sound even more rich. More coupling means more tube stages. We tried seven tube stages and saw a more complex modulation and heard more depth. Nine

stages gave more depth, and eleven stages even more. Beyond this point the extremely high gain of the system became a problem, but we determined that eleven stages would be manageable. The resulting overdrive sound has a depth and a degree of complexity never achieved before.

With eleven tube stages operated in cascade there were quite a few variables to work with and it took many weeks to finally arrive at the configuration that we provide in the *Quad X-Amp*. The name for our new circuit was fairly obvious: the Tube Cascade™.

### 6.3 Tube Maintenance and Troubleshooting

The *Quad X-Amp* employs nine 12AX7A tubes. These tubes all perform preamplifier functions and are operated well within the tube's maximum ratings. As a result, the tubes should have a very long life span and no routine maintenance will normally be required. In many cases the tubes will likely last the life of the preamp.

Like any electronic component, there will be occasional tube failures. Some of the symptoms of a bad tube would include: crackling noises, rattle, hum, or even a dead channel. Should you ever experience any of these problems you will need to take corrective action. You could return the unit to Carvin for repair but in most cases, with just a little effort, you will be able to locate the defective tube or tubes and replace them yourself. Following is a procedure for identifying a bad tube and replacing it. 12AX7A tubes are among the most commonly used tubes for guitar amps so you should have no trouble finding a new replacement tube. If you can't find a local source (check the music dealers) then you can purchase replacement tubes directly from Carvin. Equivalent tubes to the 12AX7A are: 12AX7, 7025, and ECC83 (alternate names for the same tube). In a pinch you could use a 12AY7, 12AU7A (aka: 6189, ECC82), or 12AT7 (aka: ECC81 or 6201).

#### How to Identify a Defective Tube

1. Turn the unit on and determine which channel is experiencing problems. If the problem is in all channels then it is probably not a tube problem and you should call Carvin for further instructions on having the unit repaired. If the problem is only with some of the channels then proceed as follows.

**At this point you will need to remove the top cover to get to the tubes.**

**CAUTION do not touch anything except the glass tube bulbs!**

2. If the problem is with channels 1 or 2 or both then the suspect tube is V1. V1 is the tube located at the far left of the unit as you look at it from the front. Try replacing this tube with a known good (new) tube. If the problem is corrected then replace the cover and enjoy. If not, call us for assistance.
3. If the problem is with channel 3 then check V2, V3, and V4 by listening to the amp's output while you tap (pluck) each of these tubes with your fingernail. A bad tube will usually reveal itself with a crackling sound when it is tapped. Replace any bad tubes.
4. If the problem is with channel 4 then check V4, V5, V6, V7, V8, and V9 as in step 3 above. Replace any bad tubes.
5. If you cannot correct the problem please call Carvin for further assistance.

Section

7

# Using the MIDI Interface

## 7.0 About the *Quad X-Amp* MIDI Interface

The *Quad X-Amp* MIDI interface allows you to select the four *Quad X-Amp* channels through MIDI control. The unit has been equipped with a MIDI IN and a MIDI THRU to allow you to patch your MIDI signal to external MIDI gear. The main advantage of having MIDI in control of your amplifier and effects units is that it will allow you to make real time changes to the *Quad X-Amp* and all of your MIDI effects by pressing just a single button on your MIDI footswitch.

### 7.1 Setting MIDI Channels

In order to use the MIDI features of your *Quad X-Amp* you first must set the MIDI Channel (1-16) on which to receive MIDI program change information. To select a MIDI channel set the dip switches on the rear panel to the desired setting. This is done by configuring the four switches to either 0 or 1 (left or right) to match the channel as indicated by the MIDI CHANNEL chart. The easiest way to do this is to insert the tip of a pencil through the opening in the rear panel and push the switch to the desired location. The unit is set to channel 1 as shipped from the factory.

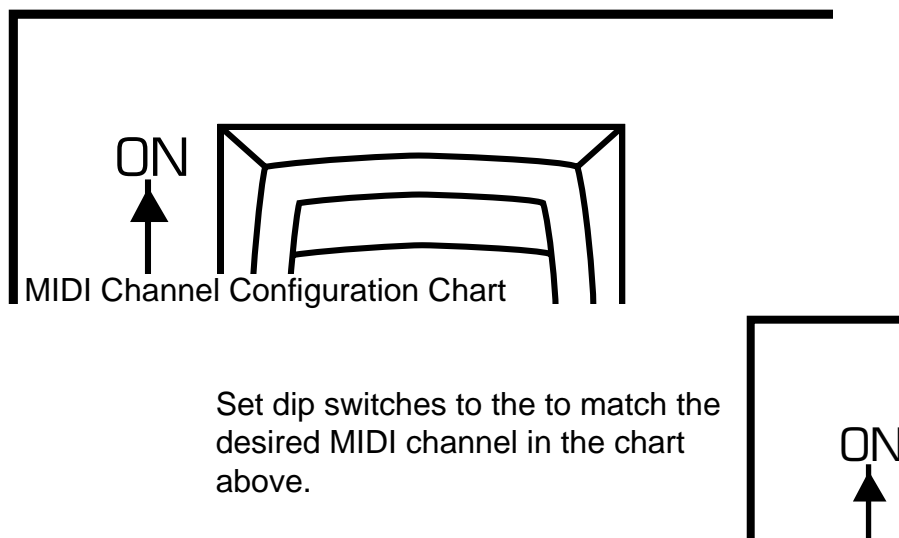

## 7.2 MIDI Patch Configuration

The *Quad X-Amp* is setup with a pre-defined MIDI Patch configuration that defines which *Quad X-Amp* channel will be selected for each of the 1-128 MIDI Patch calls. This configuration has been setup to offer you the maximum flexibility in your system. Patches 1-65 advance in a sequential pattern, (CH1,CH2,CH3,CH4,CH4) this allows the *Quad X-Amp* Channel 1 to be accessible by the first patch in each bank of ten on your MIDI footswitch. Patches 66-128 advance in blocks of five (Patches 66-70 are CH1, Patches 71-75 = CH2 and so on) this allows you to configure your effects units around the individual *Quad X-Amp* channels. To see exactly which Channel is selected by which MIDI Patch call refer to the table below.

*Quad X-Amp* MIDI Channel Selection Chart

MIDI PATCH	QUAD X Channel	MIDI PATCH	QUAD X Channel	MIDI PATCH	QUAD X Channel	MIDI PATCH	QUAD X Channel
1	1	33	3	65	4	97	3
2	2	34	4	66	1	98	3
3	3	35	4	67	1	99	3
4	4	36	1	68	1	100	3
5	4	37	2	69	1	101	4
6	1	38	3	70	1	102	4
7	2	39	4	71	2	103	4
8	3	40	4	72	2	104	4
9	4	41	1	73	2	105	4
10	4	42	2	74	2	106	1
11	1	43	3	75	2	107	1
12	2	44	4	76	3	108	1
13	3	45	4	77	3	109	1
14	4	46	1	78	3	110	1
15	4	47	2	79	3	111	2
16	1	48	3	80	3	112	2
17	2	49	4	81	4	113	2
18	3	50	4	82	4	114	2
19	4	51	1	83	4	115	2
20	4	52	2	84	4	116	3
21	1	53	3	85	4	117	3
22	2	54	4	86	1	118	3
23	3	55	4	87	1	119	3
24	4	56	1	88	1	120	3
25	4	57	2	89	1	121	4
26	1	58	3	90	1	122	4
27	2	59	4	91	2	123	4
28	3	60	4	92	2	124	4
29	4	61	1	93	2	125	4
30	4	62	2	94	2	126	1
31	1	63	3	95	2	127	1
32	2	64	4	96	3	128	1

### 7.3 Making MIDI Connections

Patch the output of a MIDI footswitch (or other MIDI controller) into the MIDI IN on the *Quad X-Amp*, then feed the MIDI signal from the MIDI THRU to the rest of your MIDI gear. The *Quad X-Amp* MIDI IN is equipped with a 7 pin din connector which allows your unit to power a Carvin MIDI footswitch with a single connection. The configuration on the powered MIDI IN is PIN 6=GND and PIN 7=+15VDC. In order to use the powered MIDI IN you must use a special 7 PIN MIDI cable which is available through Carvin.

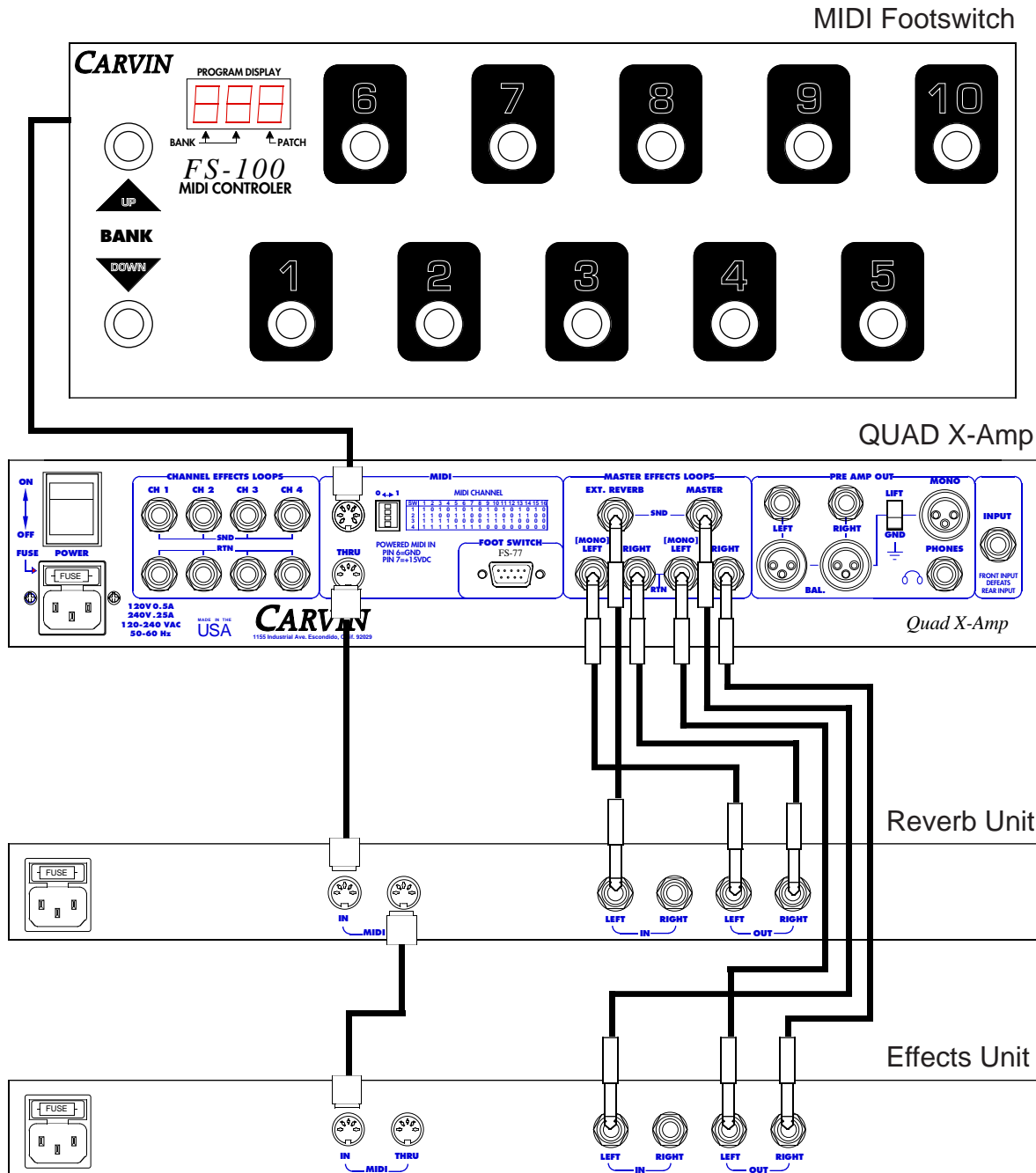

***Technical Specifications of the Quad X-Amp Preamp***

<b>Frequency Response</b>	20 to 20kHz $\pm$ 3 dB (fixed EQ defeated)
<b>Total Harmonic Distortion</b>	less than .05%
<b>Sound Quality</b>	Totally Outrageous!
<b>EQ Centers</b>	
<b>Three Band (Ch 1 &amp;4)</b>	80, 500, 3kHz
<b>Two Band (Ch 2 &amp;3)</b>	80, 3kHz
<b>Graphic EQ</b>	75, 150, 1K, 3k, 6kHz
<b>Nominal Line Output</b>	0 dBV (.775 Vrms)
<b>Maximum Line Output</b>	+22 dBV
<b>Power Requirements</b>	120/240 VAC, 50-60 Hz
<b>Warranty</b>	One year parts and labor
<b>Dimensions and Weight</b>	19" W x 10" D x 3.5" H 15lbs.

## Warranty and Service Information

You can use our specialized service department to have your amp repaired. Call us Toll-Free 800-854-2235 for your Service number so we can anticipate your shipment. Put the Service Number on the carton and be sure to include a full description of every problem when returning your unit. Pack the amp in its original carton using all its packing material and return it by UPS pre-paid. Units with physical damage, missing parts, or damage from improper service are not serviceable.

### • CALL BEFORE RETURNING

If in doubt about a malfunction, please call our service department (toll-free) and we will help you determine if your unit is defective to avoid costly shipping.

### • REPAIRS UNDER WARRANTY(1Year)

1. There is no charge for service under warranty. However, shipping is to be paid both ways by the customer.
2. Include a copy of the original invoice to verify your warranty along with a full description of the problem(s).
3. Allow approximately 10 days for servicing.
4. Include a check for return shipping charges (see the CARVIN catalog for current shipping rates).
5. Speaker Systems: If you require a loudspeaker repair, you should remove the defective component (speaker) to save shipping charges.
6. To avoid damage, ship only in the original carton.

### • REPAIRS OUT OF WARRANTY

1. After your warranty has expired, call us for the current flat rate charge which includes parts labor and testing to bring your unit up to factory specifications.
2. The return shipping charge will be listed in the current CARVIN catalog.
3. You may include your check (after you have called for your service & shipping quote) to avoid COD charges.
4. Allow approximately 10 days for repair and testing, plus shipping time.
5. To avoid damage, ship only in the original carton (save your carton).

### • SERVICING IN YOUR AREA

You may select your own service center or have your own qualified technician work on the unit at your own expense. This will not void the warranty unless damage was done because of improper servicing. Under the ONE YEAR WARRANTY, Carvin will ship parts pre-paid to you or your technician providing that the defective part(s) are first returned for our inspection. If you do not have a qualified service person, we ask that you do not involve yourself in servicing the unit.

### LIMITED WARRANTY

Your Carvin Professional Series Product is guaranteed against failure for ONE YEAR. Carvin will service the unit and supply all parts at no charge to the customer providing the unit is under warranty. The warranty period on tubes is 90 days.

**CARVIN WILL NOT PAY FOR PARTS OR SERVICING OTHER THAN OUR OWN.**

This warranty is extended to the original purchaser only and is not transferable. THIS WARRANTY DOES NOT INCLUDE FAILURES CAUSED BY INCORRECT USE, INADEQUATE CARE OF THE UNIT, OR NATURAL DISASTERS. A COPY OF THE ORIGINAL INVOICE IS REQUIRED TO VERIFY YOUR WARRANTY.

Carvin assumes no responsibility for any horn driver or speaker damaged by this unit. This warranty is in lieu of all other warranties, expressed or implied. No representative or person is authorized to represent or assume for Carvin any liability in connection with the sale or servicing of Carvin products. No liability is assumed for damage due to accident, abuse, lack of reasonable care, loss of parts, or failure to follow Carvin's directions. CARVIN SHALL NOT BE LIABLE FOR INCIDENTAL OR CONSEQUENTIAL DAMAGES.

*In the interest of creating new products and improving existing ones, Carvin is continually researching the latest state of the art audio design methods, and modern packaging and production techniques. Thus, Carvin reserves the right to make changes in its products and specifications without notice or obligation.*

**Call Us Toll Free at: 800-854-2235**

**or write:**

**CARVIN**

12340 World Trade Drive  
San Diego, CA 92128

Our business hours are Mon-Fri, 8:00AM to 4:30PM Pacific Time

# Printing Instructions

Manual Name: Quad X-Amp User's Guide

Manual No.: 76-00101D

Revision Date: 17APR96

1. The Covers are to be printed on Carvin's standard weight, beige colored, card stock.
2. The front cover is to be printed on the front side only. (master sheet 1)
3. The inside cover is to be printed on both sides (unnumbered page i, and page ii) (master sheets 2 and 3)
4. Even numbered pages are left side pages, odd numbered pages are right side pages.
5. Page viii is unnumbered, and is to be blank.
6. The last master page (unnumbered) is labeled "Carvin Quad X-Amp Block Diagram" and is to be printed on the inside of the rear cover with the title block to the right.
7. The manual is to be "comb bound" in black plastic.